

Lenkeraufnahme ø 28 mm YAMAHA XT 660 X / R
Bar Mount ø 28 mm YAMAHA XT 660 X / R

Montagehinweise

Alle vom Motorrad gelösten Schrauben sind gemäß Herstellerangaben wieder zu montieren, oder mit von SW-MOTECH gelieferten Schrauben zu ersetzen. Falls nicht anderweitig definiert, diese Schrauben nach Tabelle anziehen.

M8	23 Nm
M10	46 Nm

Gegebenenfalls Schrauben mit flüssiger Schraubensicherung einkleben.

Prüfen Sie nach 50 km alle Verbindungen auf festen Sitz.

SW-MOTECH GmbH & Co. KG
Ernteweg 8/10
35282 Rauschenberg
Germany

Tel. +49 (0) 64 25/8 16 8-00
Fax +49 (0) 64 25/8 16 8-10

info@sw-motech.com
www.sw-motech.com

Mounting Instructions







SW-MOTECH products should be installed by a qualified, experienced motorcycle technician. If you are unsure of your ability to properly install a product, please have the product installed by your local motorcycle dealer. SW-MOTECH takes no responsibility for damages caused by improper installation.

All screws, bolts and nuts, including all replacement hardware provided by SW-MOTECH, should be tightened to the torque specified in the OEM maintenance manual for your motorcycle. If no torque specifications are provided in the OEM maintenance manual, the following torques may be used:

M8	23 Nm
M10	46 Nm

All screws, bolts and nuts should be checked after driving the first 50 km to ensure that all are tightened to the proper torque.

Medium strength liquid thread-locker (i.e., "Loctite") should be used to secure all screws, bolts and nuts.

<p>1 Lenkeraufnahme Unterteil Bar Converter Lower Part</p>  <p>schwarz/silber LEH.00.039.008 00 Anzahl/ Pcs. 2</p>	<p>4 Lenkeraufnahme Oberteil Bar Converter Upper Part</p>  <p>schwarz/silber LEH.00.039.025 00 Anzahl/ Pcs. 2</p>
<p>2 Innensechskantschraube Hexagon Socket Screw</p>  <p>silber/silber M10 x 65 DIN 912 Anzahl/ Pcs. 2</p>	<p>5 Innensechskantschraube Hexagon Socket Screw</p>  <p>schwarz/silber M8 x 25 DIN 912 Anzahl/ Pcs. 4</p>
<p>3 Mutter mit Bund, selbstsichernd Lock Nut with Flange</p>  <p>silber/silber M10 DIN 6927 Anzahl/ Pcs. 2</p>	<p>6 Kunststoffkappe Plastic Cap</p>  <p>schwarz/silber KEK.00.M8.ISK Anzahl/ Pcs. 4</p>

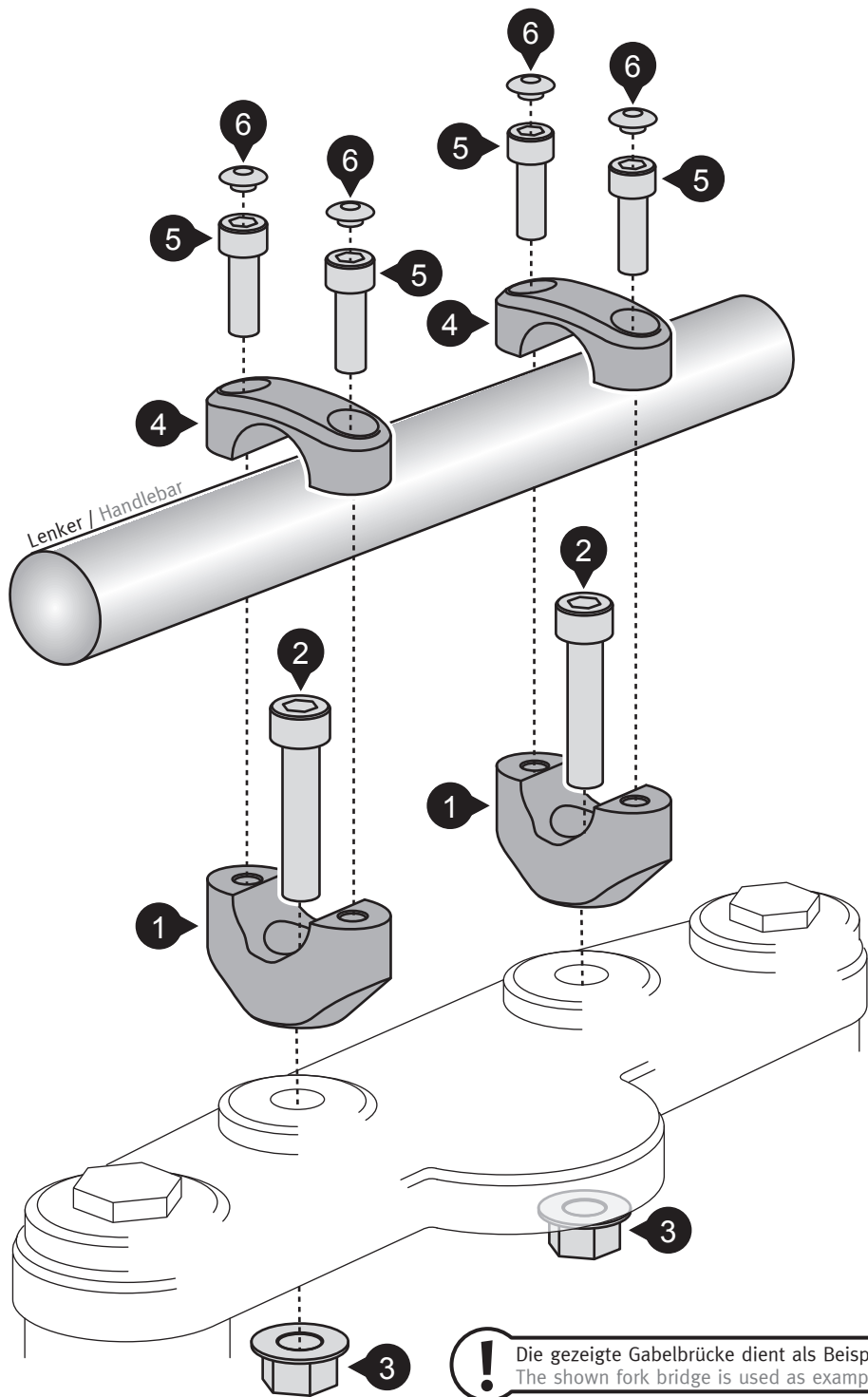

! Die gezeigte Gabelbrücke dient als Beispiel.
The shown fork bridge is used as example.